

Description

The LM7800 series are classic regulators, which are useful in a wide range of applications. For example, they can be used for local on-card regulation to eliminate the distribution and problems associated with single point regulation.

The wide range of output voltages (5V to 27V) make this series versatile in most applications. Although the 7800 series is designed as fixed output voltage regulators, they can be used as adjustable output voltage options by a few external components.

These virtually indestructible positive voltage regulators are protected by thermal shut down and internal current limiting. Most applications require no external components.

Current limiting prevents the peak output current to a safe value. Safe area protection of the output transistor limits in thermal power dissipation. In case of internal power dissipation becomes too high for the heat sinking provided the thermal shut down circuit will activate to prevent the regulators from overheating.

The LM7800 series are available in TO-220, TO-252, TO-263 packages.

Features

- Output current up to 1.5A
- Output Voltages 5V, 6V, 8V, 9V, 10V, 12V, 15V, 18V, 20V, 24V and 27V
- 3- Terminal Regulators
- Internal Thermal Overload Protection
- Internal Short-Circuit Current Limiting
- Output Transistor Safe-Area Protection
- TO-220, TO-252 and TO-263 Packages
- High Power Dissipation Capability
- Direct replacements for LM78xx series

Typical Application Circuit

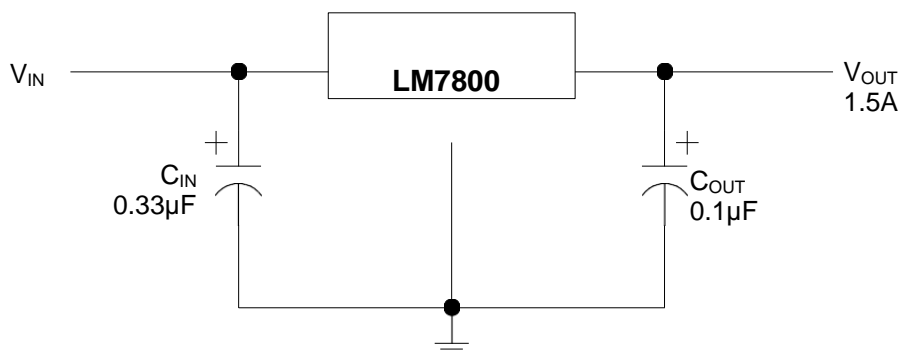

For a positive regulator, a 0.33µF bypass capacitor should be used on the input terminals. While not necessary for stability, an output capacitor of 0.1µF may be used to improve the transient response of the regulator. These capacitors should be on or as near as possible to the regulator terminals .

Marking Information and Pin Configurations (Top View)

TO 252
(D-PAK)

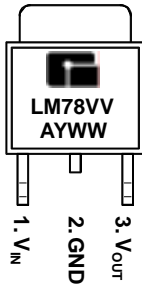

TO 220

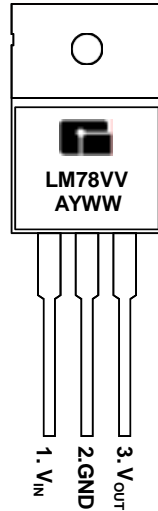

TO 263
(D²-PAK)

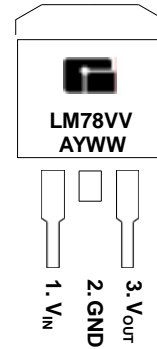

VV: Output Voltage Codes (05: 5.0V, ...12:12V)
A: Assembly/Test Site Code
Y: Year
WW: Week

Marking Information and Pin Configurations (Top View) – Green Products

TO 252
(D-PAK)

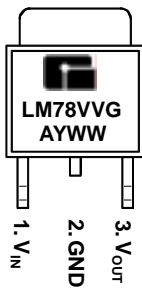

TO 220

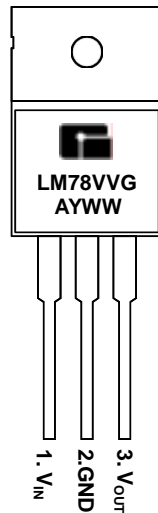

TO 263
(D²-PAK)

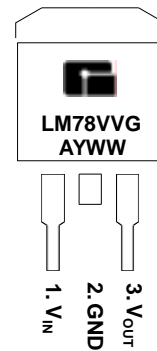

G: Green Product
VV: Output Voltage Codes (05: 5.0V, ...12:12V)
A: Assembly/Test Site Code
Y: Year
WW: Week

Ordering Information

Ordering Number	V _{OUT}	Package	Shipping
LM7800TA3T	00 = 5.0V 6.0V 8.0V 9.0V 10.0V 12.0V 15.0V 18.0V 24.0V	TO-263	50 Units/Tube
LM7800TA3R		TO-263	800 Units / Reel
LM7800TB3T		TO-220	50 Units/Tube
LM7800TC3T		TO-252	80 Units/Tube
LM7800TC3R		TO-252	80 Units/Tube
			2,500 Units / Reel

Ordering Information – Green Products

Ordering Number	V _{OUT}	Package	Shipping
LM7800TA3TG	00 = 5.0V 6.0V 8.0V 9.0V 10.0V 12.0V 15.0V 18.0V 24.0V	TO-263	50 Units/Tube
LM7800TA3RG		TO-263	800 Units / Reel
LM7800TB3TG		TO-220	50 Units/Tube
LM7800TC3TG		TO-252	80 Units/Tube
LM7800TC3RG		TO-252	80 Units/Tube
			2,500 Units / Reel

Absolute Maximum Ratings

PARAMETER		SYMBOL	RATINGS	UNITS
Input Voltage	LM7805 to LM7818	V _I	35	V
	LM7824 to LM7827		40	
Continuous total dissipation at 25°C free air temperature			2	W
Continuous total dissipation at (or below) 25°C case temperature			15	W
Operating Ambient Temperature		T _A	- 40 to 125	°C
Storage Temperature		T _{stg}	- 60 to 150	°C
Lead Temperature 1.6mm (1/6 inch) from case for 10 seconds			260	°C

Recommended Operating Conditions

PARAMETER	SYMBOL	MIN	MAX	UNITS
Input Voltage	LM7805	7	25	V
	LM7806	8	25	
	LM7808	10.5	25	
	LM7809	11.5	27	
	LM7810	12.5	28	
	LM7812	14.5	30	
	LM7815	17.5	30	
	LM7818	21	33	
	LM7820	23	36	
	LM7824	27	38	
	LM7827	30	40	

Block Diagram

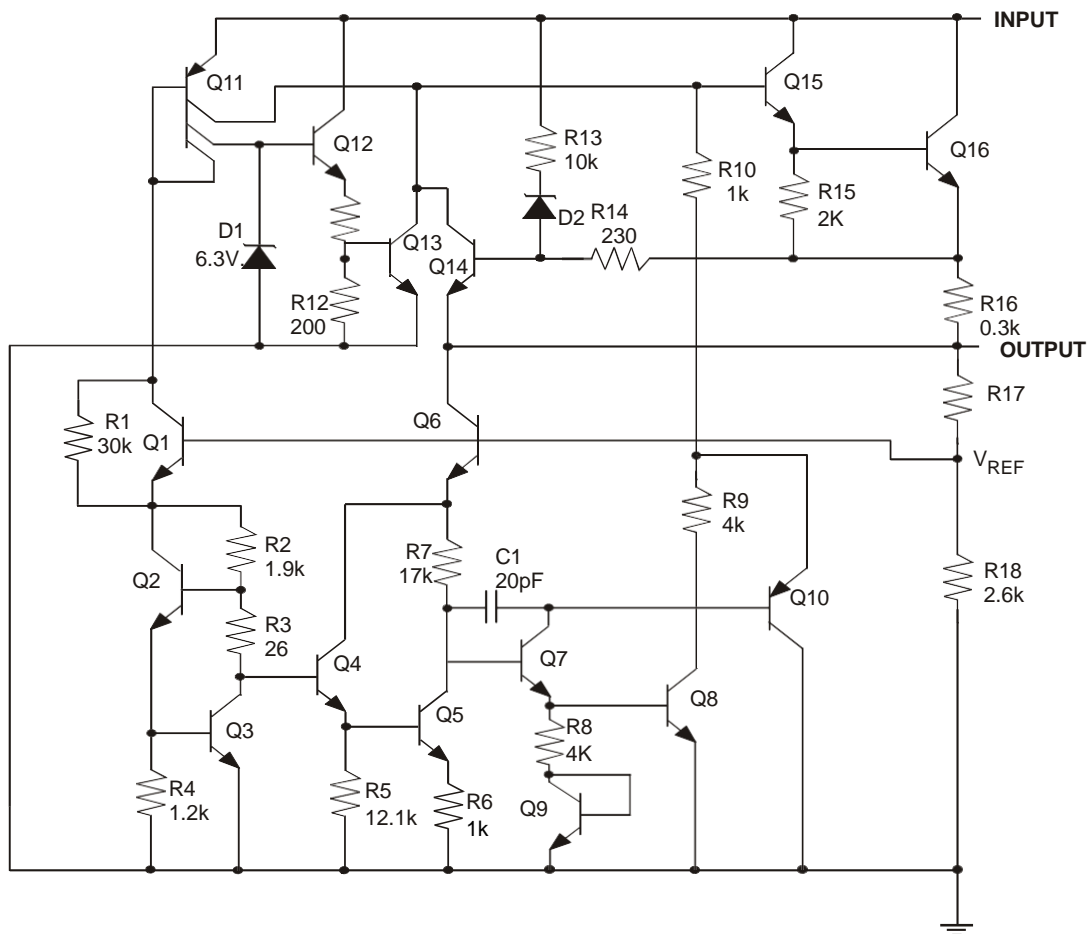

LM7805 Electrical Characteristics ($V_I = 10V$, $I_O = 500mA$ unless otherwise noted)

Parameter	Test Condition	Min	Typ	Max	Unit	
Output Voltage (note *)		25°C	4.8	5.0	5.2	V
	$I_O = 5mA$ to 1A $V_I = 7V$ to 20V, $P \leq 15W$	0°C to 125°C	4.75	5.0	5.25	
Input Regulation	$V_I = 7V$ to 25V	25°C		3	100	mV
	$V_I = 8V$ to 12V			1	50	
Ripple Rejection	$V_I = 8V$ to 18V, $f = 120KHz$	25°C	62	78	dB	
Output Regulation	$I_O = 5mA$ to 1.5A	25°C		15	100	mV
	$I_O = 250mA$ to 750mA			5	50	
Output Resistance	$f = 1KHz$	0°C to 125°C		0.017	Ω	
Temperature Coefficient of Output Voltage	$I_O = 5mA$	0°C to 125°C		-1.1	mV/°C	
Output Noise Voltage	$f = 10Hz$ to 100KHz	25°C		40	μV	
Dropout Voltage	$I_O = 1A$	25°C		2.0	V	
Bias Current		25°C		4.2	8	mA
Bias Current Change	$V_I = 7V$ to 25V	0°C to 125°C			1.3	mA
	$I_O = 5mA$ to 1A				0.5	
Short Circuit Output Current		25°C		750	mA	
Peak Output Current		25°C		2.2	A	

Note *: This specification applies only for dc power dissipation permitted by absolute maximum ratings.

LM7806 Electrical Characteristics ($V_I = 11V$, $I_O = 500mA$ unless otherwise noted)

Parameter	Test Condition	Min	Typ	Max	Unit	
Output Voltage (note *)		25°C	5.75	6.0	6.25	V
	$I_O = 5mA$ to 1A $V_I = 8V$ to 21V, $P \leq 15W$	0°C to 125°C	5.70	6.0	6.30	
Input Regulation	$V_I = 8V$ to 25V	25°C		5	120	mV
	$V_I = 9V$ to 13V			1.5	60	
Ripple Rejection	$V_I = 9V$ to 19V, $f = 120KHz$	25°C	59	75	dB	
Output Regulation	$I_O = 5mA$ to 1.5mA	25°C		14	120	mV
	$I_O = 250mA$ to 750mA			4	60	
Output Resistance	$f = 1KHz$	0°C to 125°C		0.019	Ω	
Temperature Coefficient of Output Voltage	$I_O = 5mA$	0°C to 125°C		-0.8	mV/°C	
Output Noise Voltage	$f = 10Hz$ to 100KHz	25°C		45	μV	
Dropout Voltage	$I_O = 1A$	25°C		2.0	V	
Bias Current		25°C		4.3	8	mA
Bias Current Change	$V_I = 8V$ to 25V	0°C to 125°C			1.3	mA
	$I_O = 5mA$ to 1A				0.5	
Short Circuit Output Current		25°C		550	mA	
Peak Output Current		25°C		2.2	A	

Note *: This specification applies only for dc power dissipation permitted by absolute maximum ratings.

LM7808 Electrical Characteristics ($V_I = 14V$, $I_O = 500mA$ unless otherwise noted)

Parameter	Test Condition	Min	Typ	Max	Unit	
Output Voltage (note *)		25°C	7.7	8.0	8.3	V
	$I_O = 5mA$ to 1A $V_I = 10.5V$ to 23V, $P \leq 15W$	0°C to 125°C	7.6	8.0	8.4	
Input Regulation	$V_I = 10.5V$ to 25V	25°C		6	160	mV
	$V_I = 11V$ to 17V			2	80	
Ripple Rejection	$V_I = 11.5V$ to 21.5V, $f = 120KHz$	25°C	52	72		dB
Output Regulation	$I_O = 5mA$ to 1.5A	25°C		12	160	mV
	$I_O = 250mA$ to 750mA			4	80	
Output Resistance	$f = 1KHz$	0°C to 125°C		0.016		Ω
Temperature Coefficient of Output Voltage	$I_O = 5mA$	0°C to 125°C		-0.8		mV/°C
Output Noise Voltage	$f = 10Hz$ to 100KHz	25°C		52		μV
Dropout Voltage	$I_O = 1A$	25°C		2.0		V
Bias Current		25°C		4.3	8	mA
Bias Current Change	$V_I = 11V$ to 23V	0°C to 125°C			1.5	mA
	$I_O = 1mA$ to 40mA				0.1	
Short Circuit Output Current		25°C		450		mA
Peak Output Current		25°C		2.2		A

Note *: This specification applies only for dc power dissipation permitted by absolute maximum ratings.

LM7809 Electrical Characteristics ($V_I = 16V$, $I_O = 500mA$ unless otherwise noted)

Parameter	Test Condition	Min	Typ	Max	Unit	
Output Voltage (note *)		25°C	8.6	9.0	9.4	V
	$I_O = 5mA$ to 1A $V_I = 11.5V$ to 24V, $P \leq 15W$	0°C to 125°C	8.55	9.0	9.45	
Input Regulation	$V_I = 11.5V$ to 27V	25°C		7	180	mV
	$V_I = 13V$ to 19V			2	90	
Ripple Rejection	$V_I = 12V$ to 22V, $f = 120KHz$	25°C	55	70		dB
Output Regulation	$I_O = 5mA$ to 1.5A	25°C		12	180	mV
	$I_O = 250mA$ to 750mA			4	90	
Output Resistance	$f = 1KHz$	0°C to 125°C		0.018		Ω
Temperature Coefficient of Output Voltage	$I_O = 5mA$	0°C to 125°C		-1.0		mV/°C
Output Noise Voltage	$f = 10Hz$ to 100KHz	25°C		60		μV
Dropout Voltage	$I_O = 1A$	25°C		2.0		V
Bias Current		25°C		4.3	8	mA
Bias Current Change	$V_I = 11.5V$ to 27V	0°C to 125°C			1	mA
	$I_O = 5mA$ to 1A				0.5	
Short Circuit Output Current		25°C		400		mA
Peak Output Current		25°C		2.2		A

Note *: This specification applies only for dc power dissipation permitted by absolute maximum ratings.

LM7810 Electrical Characteristics ($V_I = 17V$, $I_O = 500mA$ unless otherwise noted)

Parameter	Test Condition	Min	Typ	Max	Unit	
Output Voltage (note *)		25°C	9.6	10	10.4	V
	$I_O = 5mA$ to 1A $V_I = 12.5V$ to 25V, $P \leq 15W$	0°C to 125°C	9.5	10	10.5	
Input Regulation	$V_I = 12.5V$ to 28V	25°C		7	200	mV
	$V_I = 14V$ to 20V			2	100	
Ripple Rejection	$V_I = 13V$ to 23V, $f = 120KHz$	25°C	55	71		dB
Output Regulation	$I_O = 5mA$ to 1.5A	25°C		12	200	mV
	$I_O = 250mA$ to 750mA			4	100	
Output Resistance	$f = 1KHz$	0°C to 125°C		0.018		Ω
Temperature Coefficient of Output Voltage	$I_O = 5mA$	0°C to 125°C		-1.0		mV/°C
Output Noise Voltage	$f = 10Hz$ to 100KHz	25°C		70		μV
Dropout Voltage	$I_O = 1A$	25°C		2.0		V
Bias Current		25°C		4.3	8	mA
Bias Current Change	$V_I = 12.5V$ to 28V	0°C to 125°C			1	mA
	$I_O = 5mA$ to 1A				0.5	
Short Circuit Output Current		25°C		400		mA
Peak Output Current		25°C		2.2		A

Note *: This specification applies only for dc power dissipation permitted by absolute maximum ratings.

LM7812 Electrical Characteristics ($V_I = 19V$, $I_O = 500mA$ unless otherwise noted)

Parameter	Test Condition	Min	Typ	Max	Unit	
Output Voltage (note *)		25°C	11.5	12	12.5	V
	$I_O = 5mA$ to 1A $V_I = 14.5V$ to 27V, $P \leq 15W$	0°C to 125°C	11.4	12	12.6	
Input Regulation	$V_I = 14.5V$ to 30V	25°C		10	240	mV
	$V_I = 16V$ to 22V			3	120	
Ripple Rejection	$V_I = 15V$ to 25V, $f = 120KHz$	25°C	55	71		dB
Output Regulation	$I_O = 5mA$ to 1.5A	25°C		12	240	mV
	$I_O = 250mA$ to 750mA			4	120	
Output Resistance	$f = 1KHz$	0°C to 125°C		0.018		Ω
Temperature Coefficient of Output Voltage	$I_O = 5mA$	0°C to 125°C		-1.0		mV/°C
Output Noise Voltage	$f = 10Hz$ to 100KHz	25°C		70		μV
Dropout Voltage	$I_O = 1A$	25°C		2.0		V
Bias Current		25°C		4.3	8	mA
Bias Current Change	$V_I = 14.5V$ to 30V	0°C to 125°C			1	mA
	$I_O = 5mA$ to 1A				0.5	
Short Circuit Output Current		25°C		350		mA
Peak Output Current		25°C		2.2		A

Note *: This specification applies only for dc power dissipation permitted by absolute maximum ratings.

LM7815 Electrical Characteristics ($V_I = 23V$, $I_O = 500mA$ unless otherwise noted)

Parameter	Test Condition	Min	Typ	Max	Unit	
Output Voltage (note *)		25°C	14.4	15	15.6	V
	$I_O = 5mA$ to 1A $V_I = 17.5V$ to 30V, $P \leq 15W$	0°C to 125°C	14.25	15	15.75	
Input Regulation	$V_I = 17.5V$ to 30V	25°C		12	300	mV
	$V_I = 20V$ to 26V			3	150	
Ripple Rejection	$V_I = 18.5V$ to 28.5V, $f = 120KHz$	25°C	54	70		dB
Output Regulation	$I_O = 5mA$ to 1.5A	25°C		12	300	mV
	$I_O = 250mA$ to 750mA			4	150	
Output Resistance	$f = 1KHz$	0°C to 125°C		0.019		Ω
Temperature Coefficient of Output Voltage	$I_O = 5mA$	0°C to 125°C		-1.0		mV/°C
Output Noise Voltage	$f = 10Hz$ to 100KHz	25°C		90		μV
Dropout Voltage	$I_O = 1A$	25°C		2.0		V
Bias Current		25°C		4.3	8	mA
Bias Current Change	$V_I = 17.5V$ to 30V	0°C to 125°C			1	mA
	$I_O = 5mA$ to 1A				0.5	
Short Circuit Output Current		25°C		350		mA
Peak Output Current		25°C		2.2		A

Note *: This specification applies only for dc power dissipation permitted by absolute maximum ratings.

LM7818 Electrical Characteristics ($V_I = 27V$, $I_O = 500mA$ unless otherwise noted)

Parameter	Test Condition	Min	Typ	Max	Unit	
Output Voltage (note *)		25°C	17.3	18	18.7	V
	$I_O = 5mA$ to 1A $V_I = 21V$ to 33V, $P \leq 15W$	0°C to 125°C	17.1	18	18.9	
Input Regulation	$V_I = 21V$ to 33V	25°C		15	360	mV
	$V_I = 24V$ to 30V			5	180	
Ripple Rejection	$V_I = 22V$ to 32V, $f = 120KHz$	25°C	53	69		dB
Output Regulation	$I_O = 5mA$ to 1.5A	25°C		12	360	mV
	$I_O = 250mA$ to 750mA			4	180	
Output Resistance	$f = 1KHz$	0°C to 125°C		0.022		Ω
Temperature Coefficient of Output Voltage	$I_O = 5mA$	0°C to 125°C		-1.0		mV/°C
Output Noise Voltage	$f = 10Hz$ to 100KHz	25°C		110		μV
Dropout Voltage	$I_O = 1A$	25°C		2.0		V
Bias Current		25°C		4.5	8	mA
Bias Current Change	$V_I = 21V$ to 33V	0°C to 125°C			1	mA
	$I_O = 5mA$ to 1A				0.5	
Short Circuit Output Current		25°C		200		mA
Peak Output Current		25°C		2.1		A

Note *: This specification applies only for dc power dissipation permitted by absolute maximum ratings.

LM7824 Electrical Characteristics ($V_I = 33V$, $I_O = 500mA$ unless otherwise noted)

Parameter	Test Condition	Min	Typ	Max	Unit
Output Voltage (note *)	25°C	23	24	25	V
	$I_O = 5mA$ to 1A $V_I = 27V$ to 38V, $P \leq 15W$	22.8	24	25.2	
Input Regulation	$V_I = 27V$ to 38V	25°C	18	480	mV
	$V_I = 30V$ to 36V		6	240	
Ripple Rejection	$V_I = 28V$ to 38V, $f = 120KHz$	25°C	50	66	dB
Output Regulation	$I_O = 5mA$ to 1.5A	25°C	12	480	mV
	$I_O = 250mA$ to 750mA		4	240	
Output Resistance	$f = 1KHz$	0°C to 125°C	0.028		Ω
Temperature Coefficient of Output Voltage	$I_O = 5mA$	0°C to 125°C	-1.5		mV/°C
Output Noise Voltage	$f = 10Hz$ to 100KHz	25°C	170		μV
Dropout Voltage	$I_O = 1A$	25°C	2.0		V
Bias Current		25°C	4.6	8	mA
Bias Current Change	$V_I = 27V$ to 38V	0°C to 125°C		1	mA
	$I_O = 5mA$ to 1A			0.5	
Short Circuit Output Current		25°C	150		mA
Peak Output Current		25°C	2.1		A

Note *: This specification applies only for dc power dissipation permitted by absolute maximum ratings.

Package Outline Dimensions – TO263

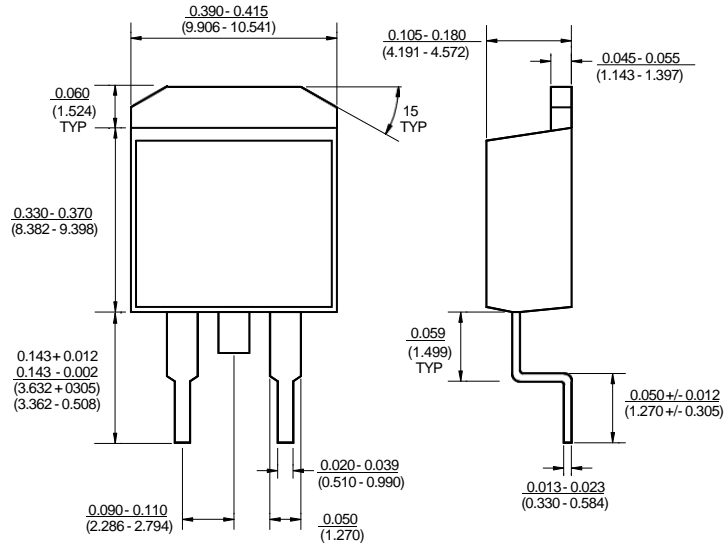

Package Outline Dimensions – TO252

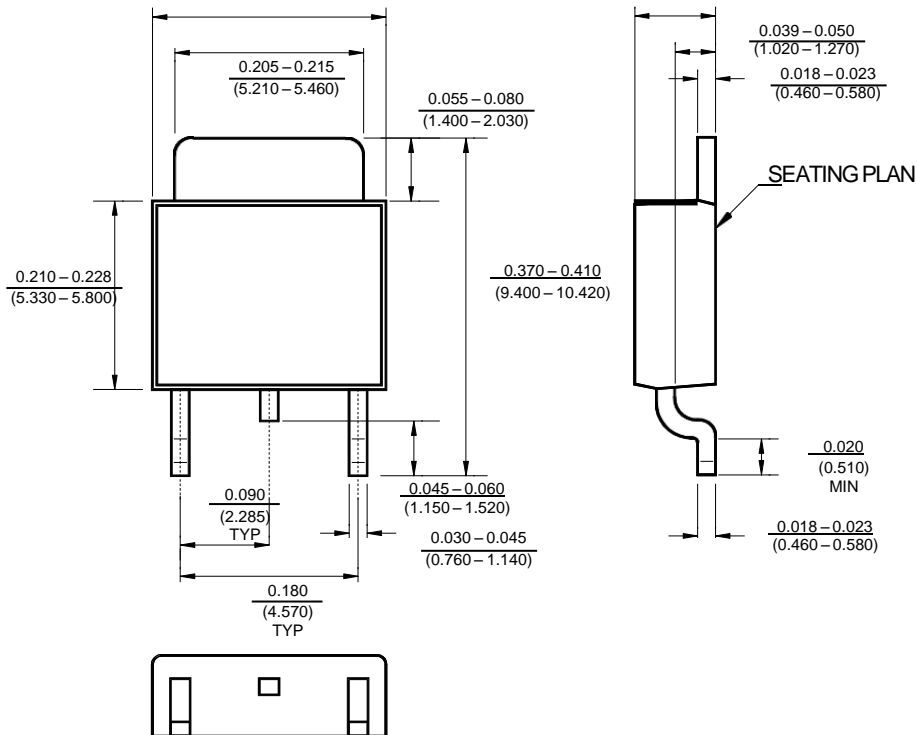

Ordering Number

LM	78	05	TA3	I	G
APM Gamma Micro	Circuit Type	Output Voltage	Package Type	Shipping Type	Blank:Pb-free G:Green
		05: 5.0V 06: 6.0V 08: 8.0V 09: 9.0V 10: 10V 12: 12V 15: 15V 18: 18V 24: 24V	TA3: TO263 TB3: TO220 TC3: TO252	R: Taping & Reel T: Tube	

Note:

Pb-free products:

- ◆ RoHS compliant and compatible with the current requirements of IPC/JEDEC J-STD-020.
- ◆ Suitable for use in SnPb or Pb-free soldering processes with 100% matte tin (Sn) plating.

Green products:

- ◆ Lead-free (RoHS compliant)
- ◆ Halogen free (Br or Cl does not exceed 900ppm by weight in homogeneous material and total of Br and Cl does not exceed 1500ppm by weight)